

Fly-over Terbregseplein

Incremental Launching Method

Auteur Erik Maarten Vermeulen
Datum 16-03-2023



Inhoud

- K52A: wat wordt er precies gebouwd?
- Incremental Launching Method: hoe werkt dat?
- De uitvoering: een kijkje in de keuken

K52A: Algemeen

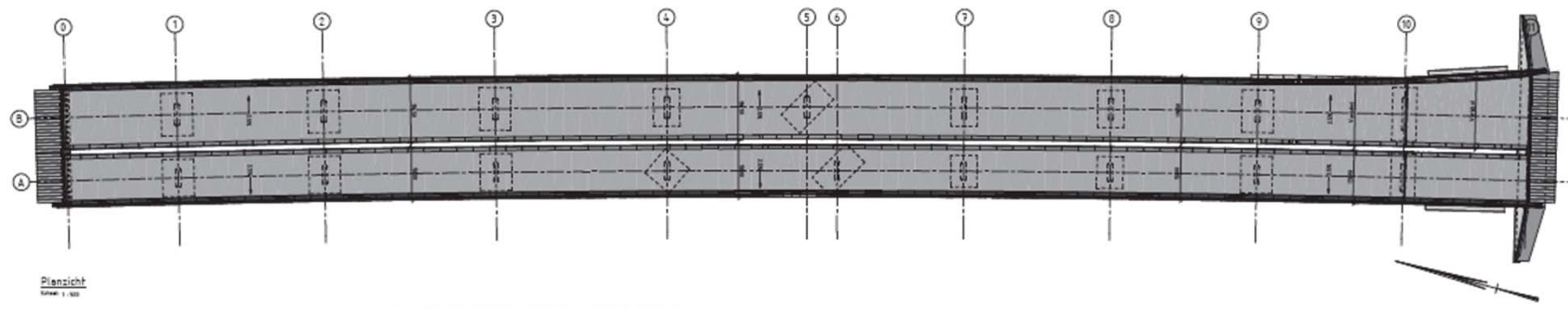
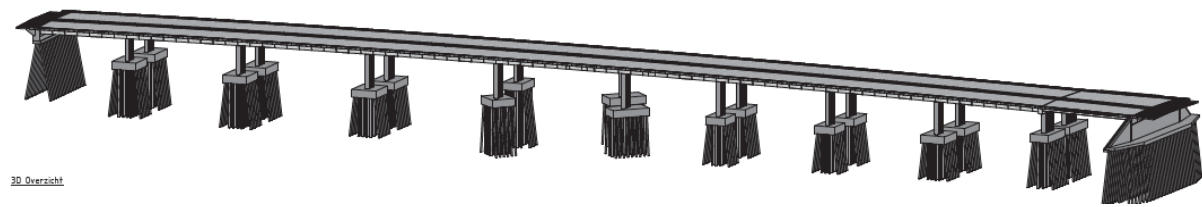
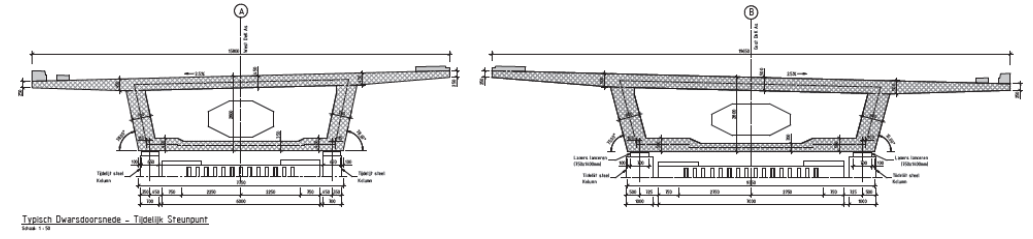

K52A: Vormgeving

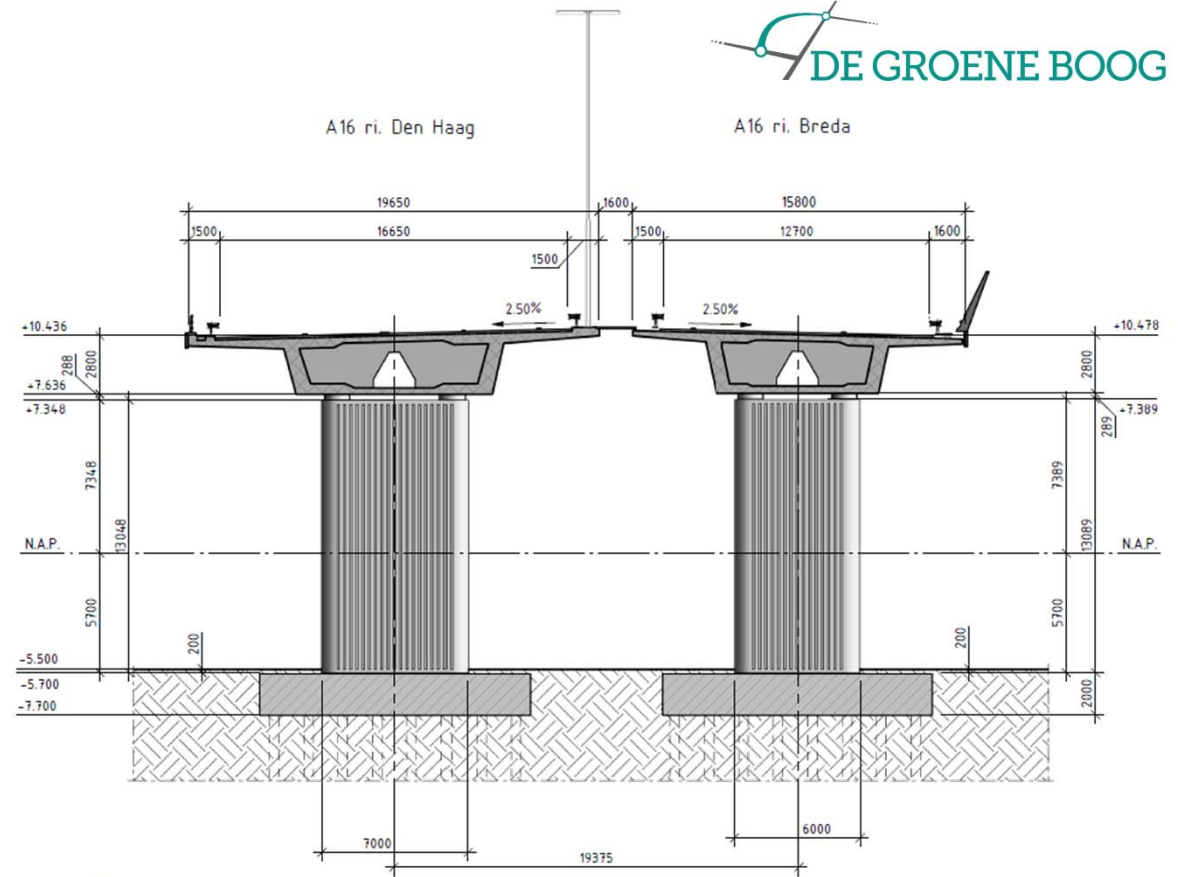
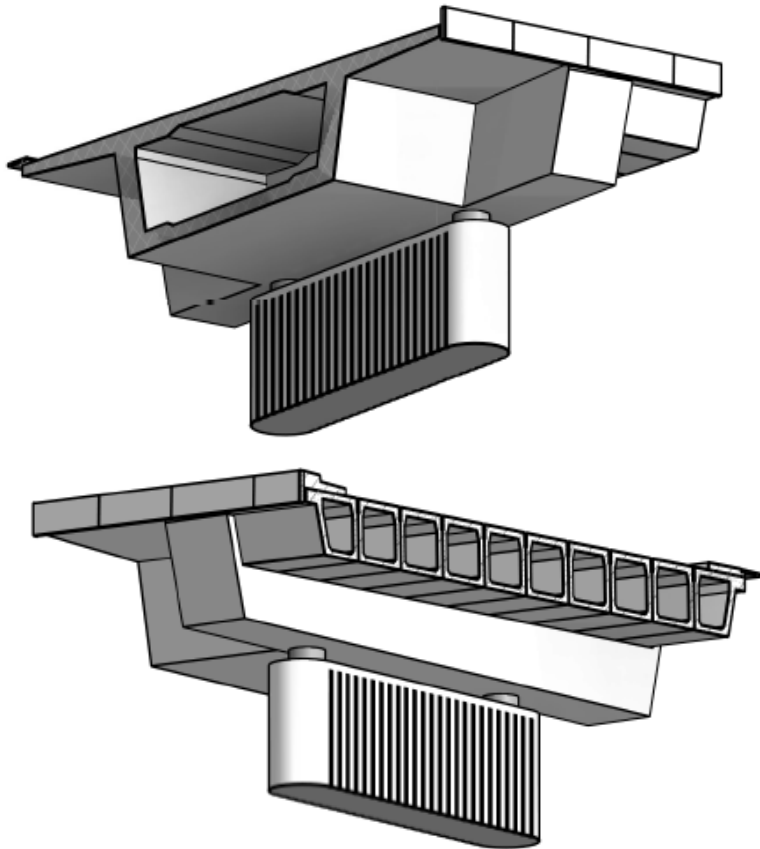

Dwarsdoorsnede brugdekken

Incremental Launching Method (ILM)

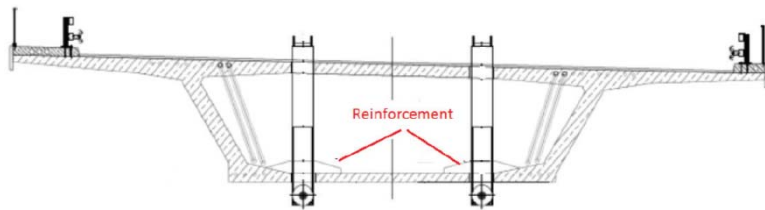
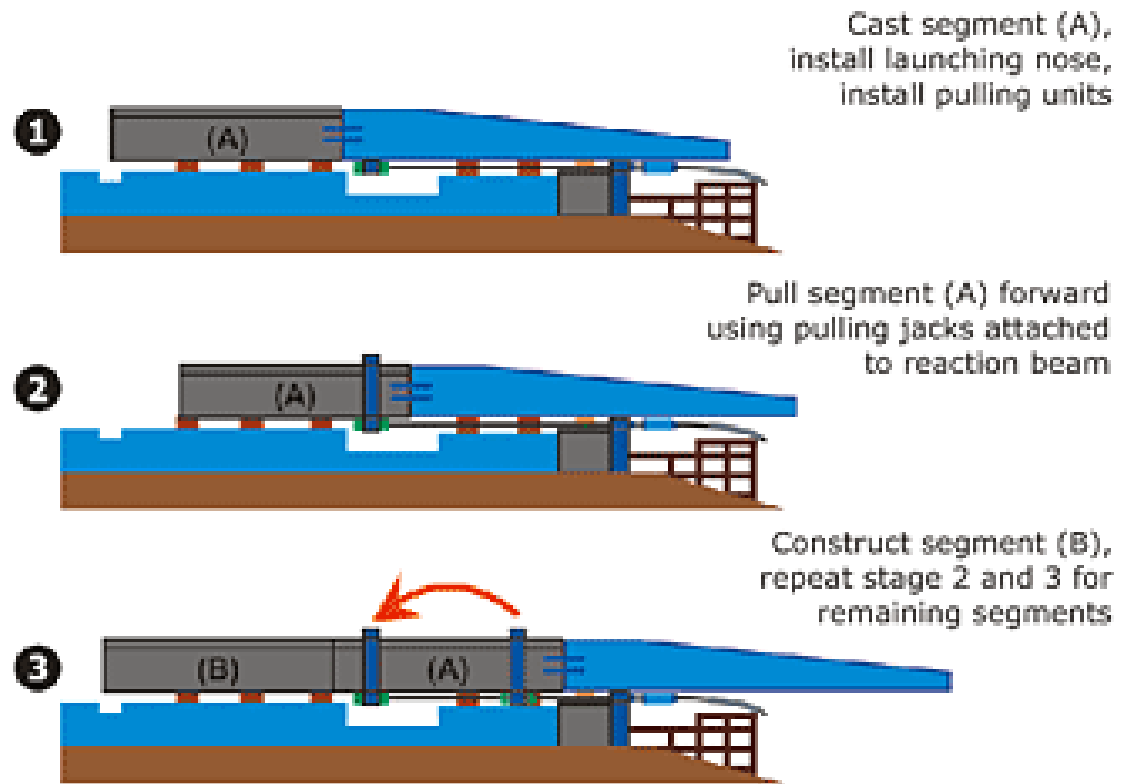
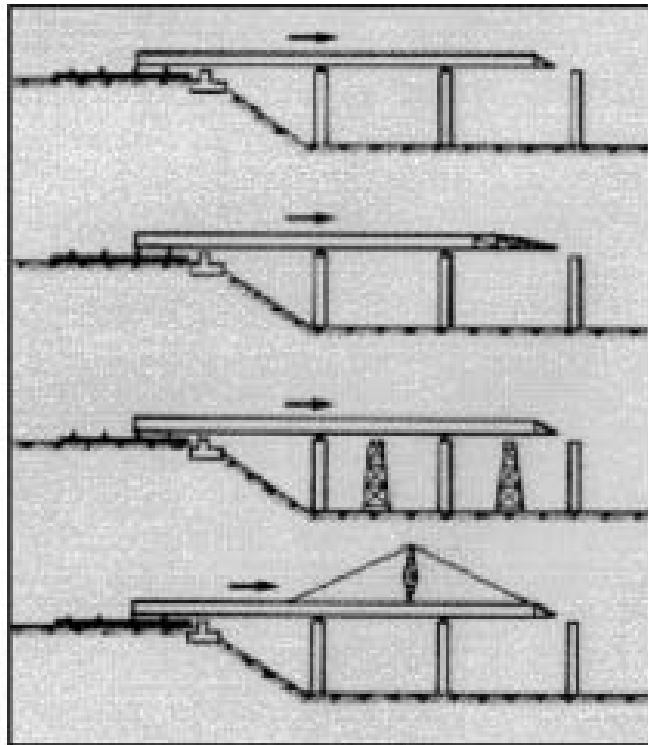

Figure 3. Pulling stick installation and segment reinforcement



Incremental Launching Method (ILM)



Incremental Launching Method (ILM)



De uitvoering

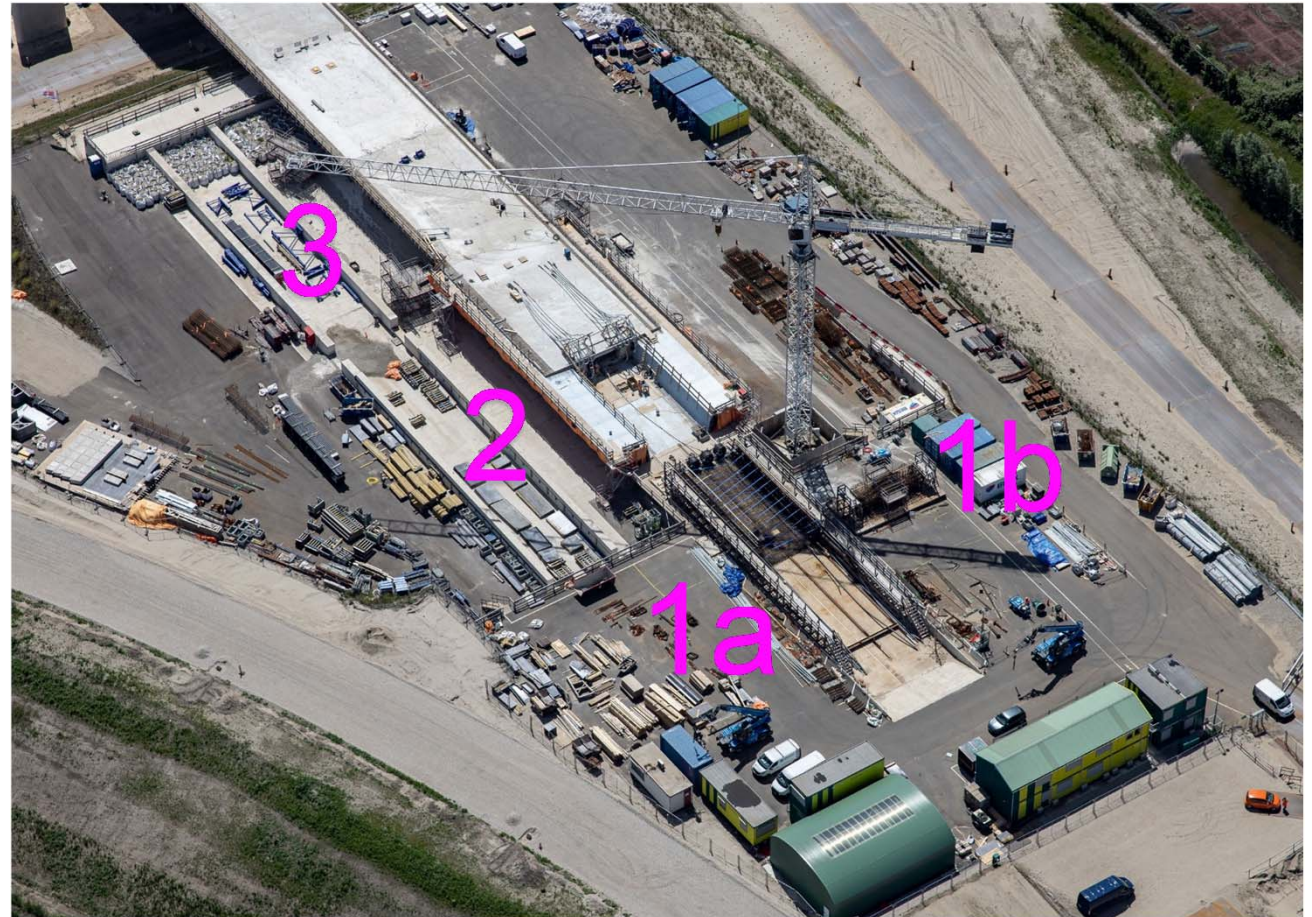

De uitvoering: Prefab Area



De uitvoering: Inrijden wapening



De uitvoering: Kist

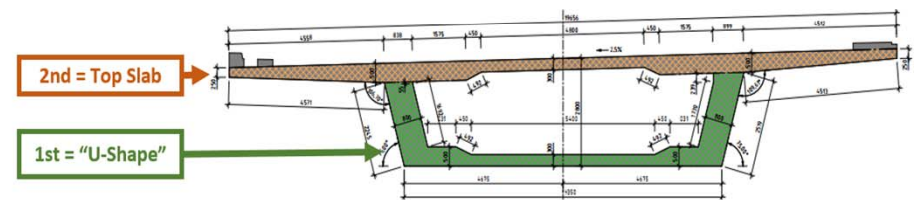

De uitvoering: Lancering



De uitvoering: wat maakt het bijzonder?

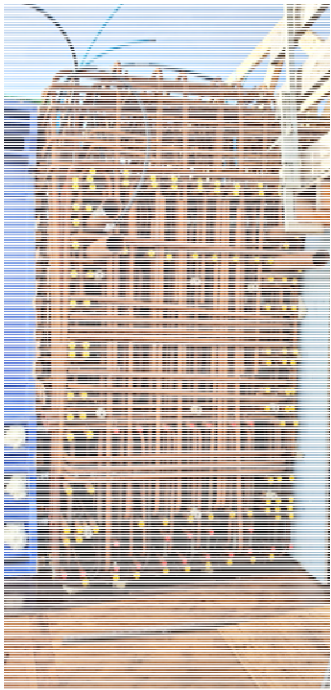

17-3-2023



© 2018 De Groene Boog. All Rights Reserved.

Vragen?

